

## 230V ~ / 12 V

- > fencee **power DUORF PDX10**
- > fencee **power DUORF PDX20**
- > fencee **power DUORF PDX30**
- > fencee **power DUORF PDX40**
- > fencee **power DUORF PDX50**
- > fencee **power DUORF PDX70**

	STORED ENERGY	OUTPUT ENERGY	OUTPUT VOLTAGE	OUTPUT VOLTAGE 500 Ω	SWITCHING ON / OFF	TEOR. MAX. CEE			
fencee <b>power DUORF PDX10</b>	1,4 J	1 J	9000 V	5000 V	✓	35 km	8 km	2 km	1,5 km
fencee <b>power DUORF PDX20</b>	3 J	2 J	12 000 V	6000 V	✓	60 km	15 km	3 km	1,5 km
fencee <b>power DUORF PDX30</b>	4,5 J	3 J	11 200 V	6400 V	✓	100 km	23 km	5 km	2 km
fencee <b>power DUORF PDX40</b>	5,7 J	4 J	10 000 V	5500 V	✓	120 km	30 km	8 km	3 km
fencee <b>power DUORF PDX50</b>	7,5 J	5 J	11 000 V	6600 V	✓	140 km	40 km	10 km	4 km
fencee <b>power DUORF PDX70</b>	10 J	7 J	10 500 V	7500 V	✓	180 km	70 km	17 km	8 km

# DECLARATION OF CONFORMITY

## Manufacturer:

VNT electronics s.r.o.  
Dvorská 605, 563 01 Lanškroun  
Company ID-No.: 64793826  
declares that the below listed products:

## ENERGIZERS FOR ELECTRIC FENCES

fencee **power DUORF PDX10**, fencee **power DUORF PDX20**

fencee **power DUORF PDX30**, fencee **power DUORF PDX40**

fencee **power DUORF PDX50**, fencee **power DUORF PDX70**

are in accordance with requirements of standards  
and regulations relevant for given type of devices:

**2014/35/EU**

**2014/30/EU**

**2014/53/EU**



Products are safe under condition of their conventional use  
in accordance with instructions for use. Declaration  
of conformity is issued pursuant to these materials:

## Test Report No.:

**38 139**

Issued by accredited **Státní zkušebnou strojů a.s.**,  
Třanovského 622/11, 163 00, Praha 6.

This declaration is issued at explicit responsibility of the manufacturer.

---

In Lanškroun March 7th, 2019

Ing. Jan Horák  
Executive Head of the Company  
Phone: +420 730 893 828  
info@fencee.eu  
**www.fencee.eu**



Thank you for purchasing the product fence   
of the company **VNT electronics s.r.o.**

The equipment conforms to safety regulations in accordance with  
valid legislation as well as relevant EU (CE) regulations.

**We also ask you to read these instructions for use before using the device carefully  
and to keep it for possible application in the future.**

**Electric fence must be constructed so that persons are protected against  
unintentional contact with pulses conductors under normal operating conditions.**

From the point of view of legislation, especially the standard **2014/35/EU - 2014/30/EU**  
(Low Voltage Directive - Electric appliances for domestics and similar purposes – Safety - Part  
2-76: Special requirement on energizers for electric fences) relate to the fences.

**R&TTE EN300-220 a EN 61000-6-3:2007 + A1:2011**

## CONTENT

<b>1</b>	Introduction .....	3
<b>2</b>	Description of the energizer for electric fence .....	4
<b>3</b>	Remote controller .....	7
<b>4</b>	Display .....	8
<b>5</b>	Keypad .....	10
<b>6</b>	States of the fencee <b>power DUO RF PDX</b> .....	12
<b>7</b>	Main screen .....	13
<b>8</b>	Settings .....	13
<b>9</b>	Pairing .....	14
<b>10</b>	Alarms .....	15
<b>11</b>	Functionality of the electric fence .....	16
<b>12</b>	Installation of the energizer .....	17
<b>13</b>	Earthing .....	18
<b>14</b>	Safety instructions .....	18
<b>15</b>	Troubleshooting .....	23
<b>16</b>	Guarantee .....	24

## 1. INTRODUCTION

**By means of this device, you ensure better protection for your animals and pieces of land.**

Local conditions and circumstances always affect functionality of equipment and total protection against violation of fence may not be guaranteed therefore. Manufacturer of the energizer does not grant guarantee that not violation of electric fence installation and so escape of animals occurs. By means of installation of the electric fence, safety of animals in the enclosure or protection of a piece of land should be increased.

**Please observe the following instructions for use.**

### Important notices

- Before performing any activities on energizer or fence system, switch of the energizer.
- Read the Safety instructions carefully.
- When installing, make sure to observe all safety regulations.
- Do not connect the energizer on one fence system with another appliance.  
Lightning stroke against the fence connects to all other devices then.
- Use only original spare parts.

## 2. DESCRIPTION OF THE ENERGIZER FOR ELETRIC FENCE

Combined energizers **fencee power DUO RF PDX** can be power supplied from network 230 V with using attached adapter to 14 V or by means of a suitable 12V battery.

When operating energizer, loading of the enclosure is measured continuously. Output power of **DUO RF PDX energizer** is adjusted then automatically so that required output voltage is maintained to the smallest possible extent of loading. This regulation is significantly in favour of saving energy when using high-quality fence system with low loading. It also optimizes power consumption for maintaining sufficiently high voltage on the fence system that can be overgrown with grass for example (high loading).

The LEDs and the BARGRAPH indicator on the front of the energizer indicate power supply, the fence voltage and also indicate possible fence failure as well.

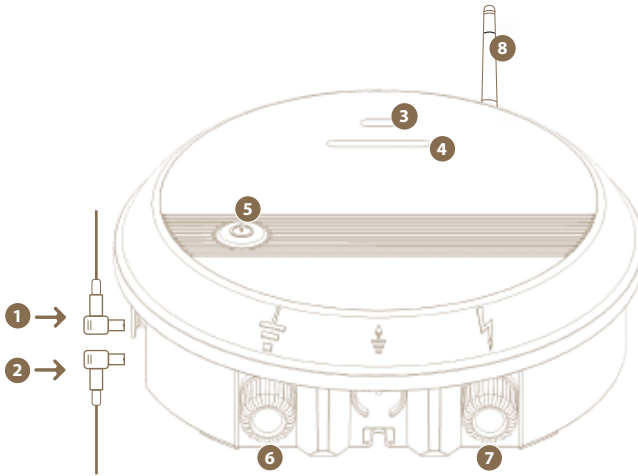

Figure No. 1: Energizer power DUO RF PDX

1	Connector for connecting adapter ( 14 V <u>DC</u> /1A)
2	Connector for connecting battery(12 V)
3	LED control of connecting energizer and status indication
4	BARGRAPH Indicator – indication of voltage on fence system
5	ON / OFF switch button
6	Earthing (black)
7	Connection to fence system (red)
8	Antenna

Table No. 1: Description of the energizer

### Explanations of symbols shown on energizer



Earthing connection. Connect this connection to your earthing system.



Fence output with full voltage. Connect this connection to your fence system.



Energizer should be opened or repaired solely by qualified persons for the reason of reducing risk of electric stroke.



Please dispose of waste in accordance with regulations valid for your country.

## EXPLANATION OF LED INDICATING LIGHTS AND BARGRAPH INDICATOR

### LED control:

#### BURNING / BLINKING

- **Blinking** – Operation on battery only
- **Permanent burning** – Operation with adapter

#### COLOR

- **Blue** – Operation at higher output (100%)
- **Purple** – Operation at lower output (c. 50%)
- **Red** – It lights up when battery voltage drops below 12 V.

When battery voltage drops below 11,6 V, warning siren is started (beeping). When battery voltage drops below 11,4 V, energizer is switched off. Reason is protection of battery from deep discharge of the battery (battery destruction). If discharged battery and adapter are connected simultaneously, red LED is burning, until battery is charged at 12 V at least.

### BARGRAPH INDICATOR:

To indicate input voltage at fence system, DUO models are equipped with BARGRAPH indicator. It consists of six LEDs - **2x red | 2x yellow | 2x green** – ordered from left to right. BARGRAPH indicator always goes through LEDs from the first red one up to indicated position where it stops for a while.

### Indicating statuses are as follows:



BARGRAPH indicator and indicating lights

- Voltage **< 3 kV** - 1x RED



- Voltage **3-5 kV** - 2x RED



- Voltage **5-6 kV** - 1x YELLOW



- Voltage **6-7 kV** - 2x YELLOW



- Voltage **7-8 kV** - 1x GREEN





- Voltage **> 8 kV** - 2x GREEN





## OUTPUT SWITCHING – ON/OFF SWITCH BUTTON

Compared to POWER models, the ON/OFF switch button has extended functionality here. After first switch-on of energizer, blue LED is burning or blinking indicating operation at higher output. After each other switch-on, the generator remembers selected mode.

### IN SWITCHED-OFF CONDITION OF THE ENERGIZER

-  long press of button (>2s) – switching energizer on
-  short press of button – no reaction

### IN SWITCHED-ON CONDITION OF THE ENERGIZER

-  long press of button (>2s) – manual switching between high and low output - optional by user for example when using it for more sensitive animals or in case of battery saving
-  first short press of button – switching energizer off to standby RF active  
second short press of button – switching energizer off completely

## OTHER IMPORTANT INFORMATION ABOUT THE DUO RF PDX MODEL

**DUO RF PDX** models do not have a connection cord, but only two input connectors. The top connector serves for connecting the adapter and the bottom connector is for connecting the battery. Ensure that the correct connection of cords is observed. If the connectors are plugged in the wrong order and both the adapter and the battery are plugged in at the same time, charging and low battery indication will not work, but there will also be no discharge of the battery. If both the adapter and the battery are plugged in at the same time, the battery recharges slightly. A typical “car battery” 12 V / 40 Ah can be charged with simultaneous connection of both the adapter and the battery in about 7 days.



### **The energizer must not be supplied with a voltage higher than 16 V.**

This is provided by an adapter that is included in the package or by operating on a classic 12 V car battery. **If a solar panel is used, there must a regulator connected, the energizer must not be connected to the solar panel. The energizer must not be connected directly to the solar panel.**

The adapter is included in the package and its polarity is shown on the diagram below. The adapter is not suitable for purposeful charging of the battery. In the event of a sudden voltage outage, the main capacitors are discharged. After the supply voltage is restored, the fence continues to function with the same power settings.

Compared to other products, **DUO RF PDX** has the same or lower consumption. **Thus, saves energy and the battery operates longer. It is necessary to observe the correct connection of the connectors.**

If the power adapter is plugged to the energizer, do not use regular batteries (only rechargeable ones). Do not let the unplugged battery cable hang freely, there is a risk of short circuit and subsequent destruction of the energizer.

When using valve-controlled batteries (gel, AGM), these batteries must be placed in a well-ventilated place.

The power adapter must be the separating part from the source.



Connection of the connectors.

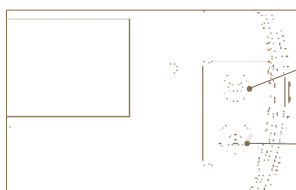

Upper  
**ADAPTER**

Lower  
**BATTERY**

### 3. REMOTE CONTROLLER

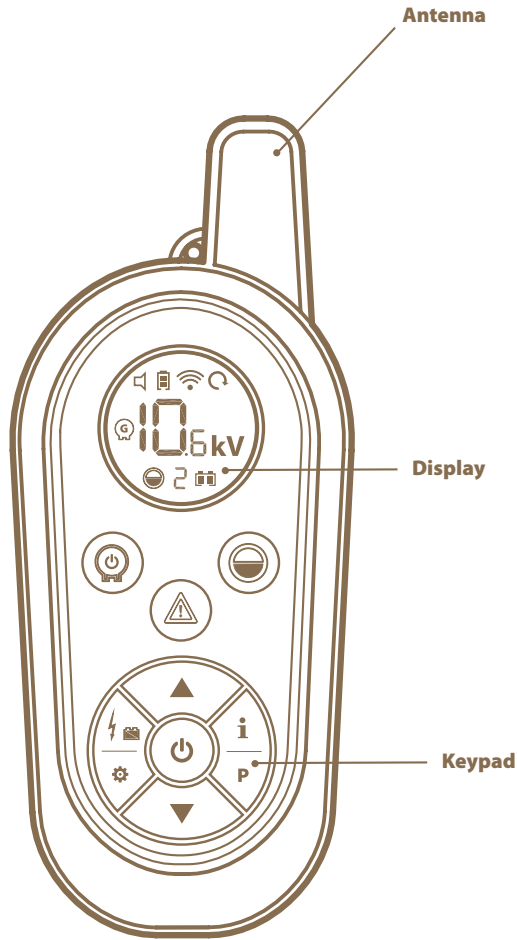

Picture 1: Remote controller

fence power DUO RF PDX can be used for up to 10 km (with direct visibility between the controller and the energiser). However, the maximum range and accuracy are affected by a number of factors — weather, terrain, vegetation, etc. In a densely forested, or built-up terrain the range will be shorter - which is not due to a defect of the device, but by the laws of physics and technical possibilities (within the permitted European standards).

**Ensuring maximum range and accuracy of the device: Check if the battery in the controller is sufficiently charged. Hold the controller as high as possible, the RF antenna must point up and be almost perpendicular to the ground.**



## 4. DISPLAY

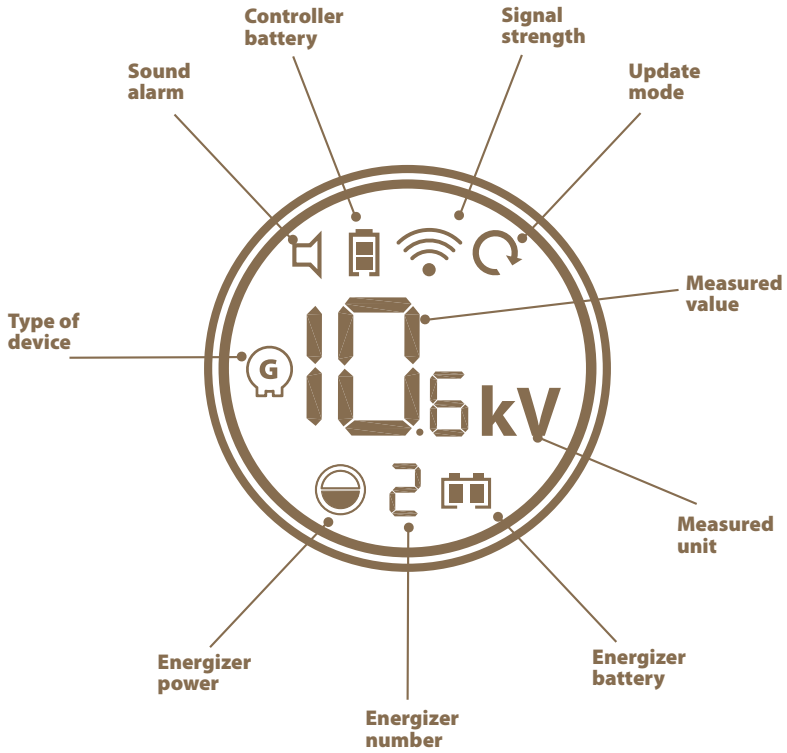

Picture 2: Display





### Sound alarm

Controller alarm sound turned on/off. Can be changed in the settings.



### Controller Battery

Current battery capacity in the controller.

Displays three states - **FULL 100%** | **HALF 50%** | **EMPTY**



### Signal strength

Indication of the quality of connection between the controller and the energizer.

### Data Update Mode

Indicates the set data update mode.



**Round arrow** – automatic mode with a frequency of 1 minute.

**Round arrow with letter i** – mode with a frequency of 1 hour.

The mode setting affects the battery life in the controller.



### Energizer power

Indicates the status of the energizer — **ON 100%** | **ON 50%** | **OFF**



### Energizer number

Number of the selected energizer. It is possible to assign up to 6 energizers to one controller.



### Energizer battery

Current battery capacity of the energizer.

Displays three states - **FULL 100%** | **HALF 50%** | **EMPTY**



### Type of device

Icon indicating the type of the selected device.

When communicating with the energizer, the icon will flash.

Currently, only the G - energizer icon is used.

### Measured value

The value measured by the energizer and sent to the controller.

### Measured unit

Unit of the measured value. Here you can see **kV** - voltage of the output pulse, or **V** - battery voltage of the energizer.

## 5. KEYPAD

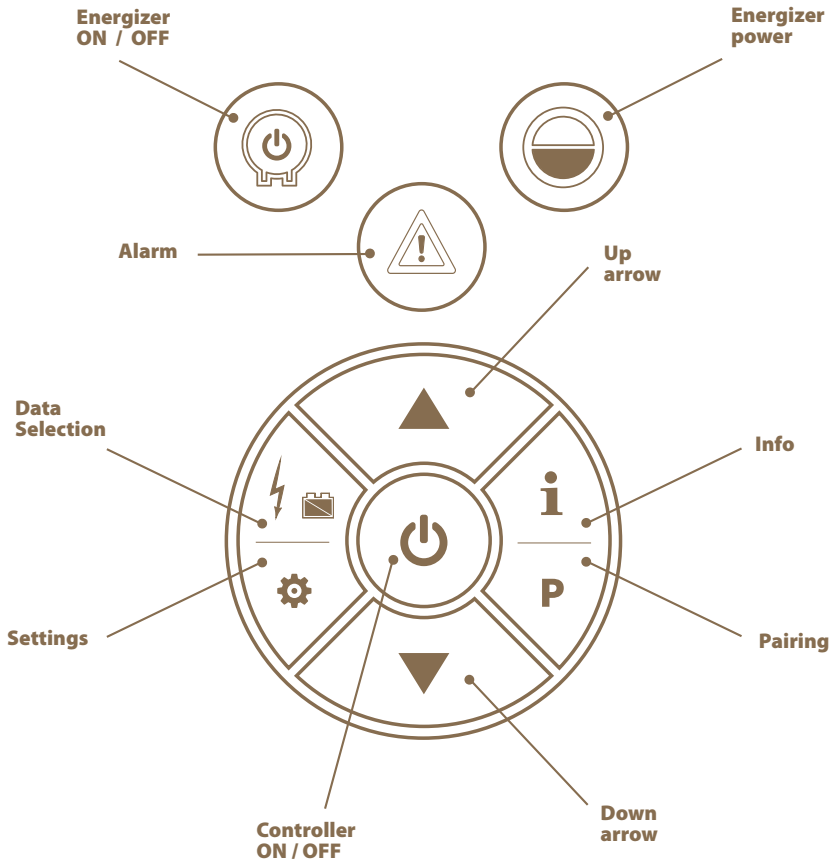

Picture 3: Keypad

**UP Arrow / DOWN Arrow (short press)**

Selection of device. Change the values in the settings mode.

**Data selection (short press)**

Toggles the data displayed on the controller. You can display the pulse voltage (kV) or the energizer battery voltage (V).

**Settings (long press)**

Switches the controller to the settings mode where you can set the behaviour of the controller.

**Settings (short press)**

Switching individual items in the settings mode.

**Turn on (short press)**

Exit the current mode. Goes back from pairing mode, or from setup mode back to the main screen.

**Turn on (long press)**

Turns the controller on or off.

**Info (short press) - manual data update**

Updates the information of the selected energizer.

**Pairing (long press)**

Switches the remote controller into the pairing mode.

**Energizer ON / OFF (short press)**

Turns the selected energizer on or off.

**Energizer power (short press)**

Switches energizer power (50% or 100%)

**Alarm (short press)**

A short press turns off the controller's beep.

**Alarm (long press)**

Long press clears the alarm notification.

## 6. STATES OF THE FENCEE POWER DUO RF PDX ENERGIZER

fencee DUO RF PDX models behave similarly to fencee DUO PD, but with several states for radio communication operation added. Switching between states is done using the button on the energizer. Transitions between states are indicated on the diagram below.

### OFF State

The energizer is completely off. It consumes almost no energy. It is not possible to control it remotely. No LED is active.

### ON State

The energizer produces impulses and communicates with the remote controller. Status LED is lit (adapter) or flashing (battery).

**BLUE colour — 100% output**

**PURPLE colour — 50% output**

**RED colour — error**

### OFF state RF active

The energizer does not produce a pulse, but it can be controlled remotely. The status LED flashes every 3 seconds.

**BLUE colour — normal state**

**RED colour — low battery voltage**

### Pairing mode

Special mode designed for assigning the energizer to the remote control. Status LED flashes BLUE very quickly.

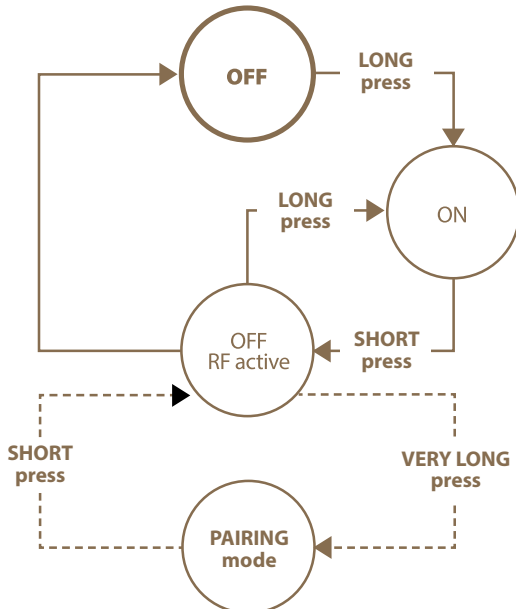

Picture 5: Energizer states

## 7. MAIN SCREEN

The energizer is controlled from the main screen.

Use the **UP** and **DOWN** arrows   to select the desired energizer.

When the **Energizer ON / OFF** or **Energizer Power** button is pressed  the controller immediately sends the command to the energizer.

Pulse voltage, or battery voltage can be monitored on the display.

To switch battery or pulse information, press the **Data Selection** button.

## 8. SETTINGS

To enter the settings mode, press (long) the **Settings** button .

There are currently 3 items available in the settings menu. To select the desired item, shortly press the **Settings** button .

To change the settings of the selected item, press the **UP** or **DOWN** arrow.  



To exit the setting mode, shortly press the red button  **ON**.

### Alarm sound (letter “A”)

Audio notification of the controller can be enabled or disabled. The setting is indicated by the speaker icon.

### Update mode (letter “U”)

Sets the data update interval.

-  Automatic mode updates the data every minute but has a higher power consumption.
-  Automatic mode updates the data every hour, saving battery.

### TIP

You can update the current energizer data at any time outside the interval by pressing the button  on the controller.

### Limit of the voltage of the fence

Pulse voltage limit on the fence can be set. If the voltage drops below the required limit, an alarm is triggered.

## 9. PAIRING

To connect the energizer to the controller, it is necessary to perform “pairing”.

- Turn on the energizer, and then turn it off with one short press of the button. Then press the button for longer time (> 5 seconds) until the status LED starts flashing fast. Now the energizer is in pairing mode.
- Press the pairing button **P** on the controller for a longer time. The letter **P** appears on the display. Now the controller is in pairing mode.
- Use the **UP** and **DOWN** arrows **▲▼** to select the desired position number on which you want to pair.
- Move the controller close to the energizer (up to 20 cm) and press the **Pairing** button **P**.
- If everything went well, the controller is now paired with the energizer. The controller switches back to the main screen and the energizer switches back to the OFF RF state.
- If the pairing process did not go through, perform it again.
- If you want to delete a position on the controller, perform pairing without an energizer.
- If the controller does not find any energizer, it deletes the paired position.
- If you want to exit the pairing mode, press the red button **Ⓞ ON**.
- It is possible to pair up to **6 energizers** to one controller — you can control 6 energizers with one controller.
- It is possible to pair up to **3 controllers** to one energizer — you can control one energizer with 3 controllers.

## 10. ALARMS

If any problem occurs, an alarm is triggered. The alarm is indicated on the controller by a flashing triangle icon  **with an exclamation mark.** At the same time, the controller starts to beep.

### Possible errors:

#### Low pulse voltage

The “**kV**” unit and the alarm icon are flashing.

#### Low battery voltage of the energizer

The energizer battery icon and the alarm icon are flashing.

#### No signal

On the main screen, the letter **E**, is displayed, the signal and alarm icon flashes.

#### General alarm

Only the **alarm** icon flashes. There may be more causes. One of them is a step change in the resistance of the fence. In this case, the fence requires physical inspection.

Press any button on the controller to turn off the sound of the alarm.

The alarm sound can be disabled in the settings.

If the problem is solved (battery replacement, fence repair...), press the **Alarm** button  for a longer time and alarm notification will be removed.

## 11. FUNCTIONALITY OF THE ELECTRIC

### HOW THE ELECTRIC FENCE WORKS

Electric fence system consist from the energizer and fencing marked with posts and conductors. The energizer creates regular high-voltage impulses that generate a voltage between the conducting material and the ground. When an animal (or a person, vegetation or similar) creates a connection between the ground and the conducting material, the circuit is completed. Generated impulses are unpleasant, but not dangerous to people or animals as they only act for a short period of time and results in the desired deterrent effect. The impulse lasts for a matter of milliseconds. These fences serve not only to enclose an area, but also act as a deterrent e.g. to protect against wild boars.

### Benefits of electric fence systems:

- electric fences are long-lasting, simple to put up and great value for money compared with normal fences.
- it is easy to assembly and flexible for using
- designed for guarding and protecting different animals.
- compared to other fences, such as barbed wire, it does not cause any damage to the animals.

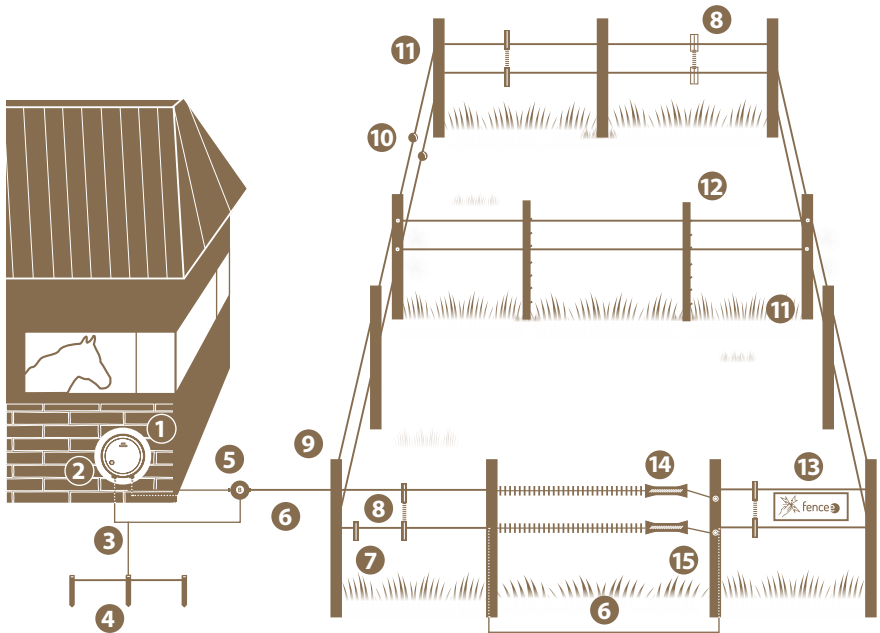

Figure No. 6: Wiring of electric fencer

1	Energizer fence	6	High-voltage connecting cable	11	Insulators
2	On/off button on energizer	7	Conductor	12	Flexible post
3	Earthing cable	8	Line connector	13	Warning sign
4	Anticorrosive earthing rod	9	Fixed post	14	Gate
5	Lightning diverter	10	Tensioner	15	Insulator of gate

Table No. 2: Description of individual parts of the fence system



## 12. INSTALLATION OF THE ENERGIZER

Before installation, please read all Safety instructions listed in these instructions for use carefully.

### Choose a place suitable for installation of energizer.

Observe the following measures when choosing a place for installation of energizer.

#### Choose a place:

- Where you can achieve a good earthing.
- Which is distant enough from children and animals
- Where energizer is well accessible.
- Where permanent water stream is avoided.

To mount energizer on wall, use attached screws, on which you can hang the energizer easily.

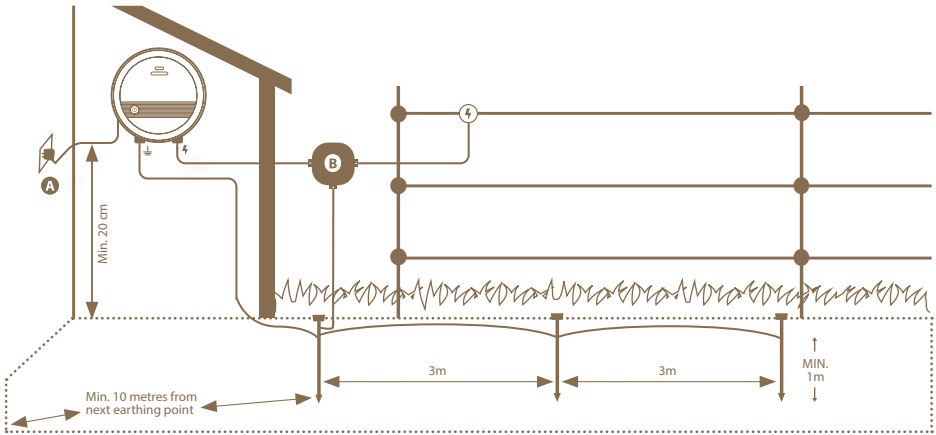

Figure No. 7: Assembly of generator and earthing

### ASSEMBLY OF ENERGIZER BY USING DIN RAIL

Energizer can be easily and practically mounted by using DIN rail and mounting bracket. Set for assembly on DIN rail can be ordered as separate accessories.

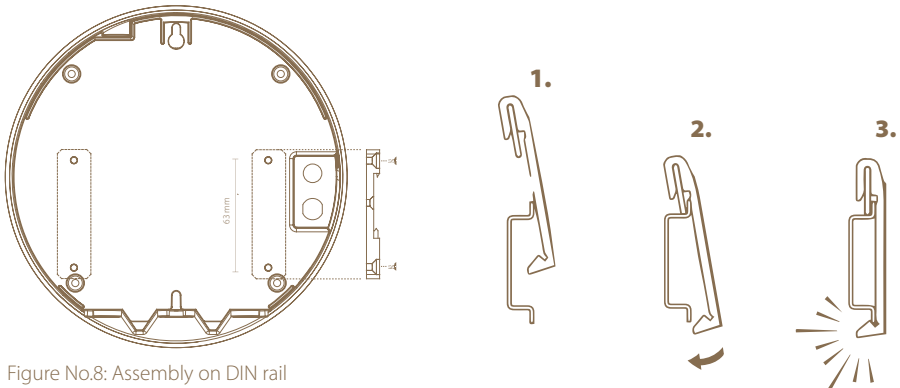

Figure No.8: Assembly on DIN rail

### 13. EARTHING

**Correct earthing is very important because total function of the fence system is dependent on it!**

Beat earthing rod with corrosion protection into ground completely at place with maximum and permanent humidity. On dry pieces of land or in case of soils with lower electric conductivity, use one or several supplementary earthing rods (with length of minimum of 1 m) and place them at distance of approximately 3 metres from each other.

Exceptions are fence system powered by battery energizer or working with low output. Here minimum length of earthing rod of 50 cm is recommended.

Distance of at least 10 metres must be between earthing rod of fence system and another earthing system, for example earthing of a house, protective earthing of electric supply system or earthing of violation alarm.

Do not connect the energizer to already existing earthing.

### 14. SAFETY INSTRUCTIONS

**Electric fence system must be operated in accordance with description mentioned in the instructions for use. We ask you to read these instructions for use thoroughly and keep them safely after successful installation.**

Electric animal fences and their ancillary equipment shall be installed, operated and maintained in a manner that minimises danger to persons, animals or their surroundings  
Prevent from using electric fence system in which animals or people could get stuck.

An electric animal fence shall not be supplied from two separate energizers or from independent fence circuits of the same energizer.

For any two separate electric animal fences, each supplied from a separate energizer independently timed, the distance between the wires of the two electric animal fences shall be at least 2,5 m. If this gap is to be closed, this shall be effected by means of electrically non-conductive material or an isolated metal barrier.

For installation of electric fence system, do not use barbed wire or razor wire or other types of wires having sharp edges.

**Energizers must be installed in a dry place.**

**Never put energizer on ground – in moist or wet environment.**

**Fasten energizer by means of hanging screw or DIN rail with mounting bracket in vertical position – at least 20 cm above ground.**

**Never expose energizer to continuous water stream.**

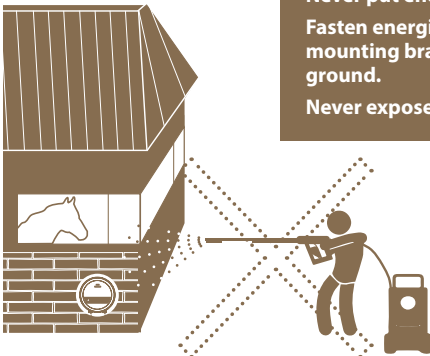

Supplementary non-conductive fencing using barbed wire or razor wire must be placed at least 150 mm from conductor of electric fence system and must be earthed at regular intervals.

All sections of electric fence system installed along public communication must be marked with warning sign fastened to posts or to fencing and visible from every point at regular intervals of the communication.

**Warning sign** (see Figure No. 5):

- It is of yellow color and minimum dimensions of 100 x 200 mm
- It includes either marking according to standard or sign "Attention – electric fence" on both sides
- Height of text must be 25 mm at minimum and data on it must be indelible
- 1 piece of it is a part of this package



Figure No. 5: Warning sign

**Energize Power DUO PD70 is capable of an output of over 5 joules.**

A delay in the increase of performance guarantees your safety.

The hourglass symbol  indicates such devices. The time delay for this unit is 50 seconds.

When the load on the fence is increased and the resistance falls below 500 Ohm, this device increases its output energy (above 5 joules) after a delay of 50 seconds. Energizer Power DUO PD70 automatically increases its shock strength, for example, in case of vegetation touching the fence, adverse weather conditions or condition of the fence itself. The unit will increase its shock strength (up to 7 joules) as long as the fence resistance is not increased or the load is not reduced.

When fence resistance suddenly drops by a significant margin (from 1000 ohms to 400 ohms or less), an alarm is triggered. This can be caused, for example, by a falling branch, a stuck animal or a human. The alarm beeps 6 times and the red LED light flashes. At the same time the interval between the impulses is extended to 3 seconds. The alarm is switched off if the load on the fence drops and the resistance increases to at least 400 ohms within 10 minutes. The energiser then continues to operate normally.

Both signals work independently of one another.

**Supply and connecting leads:**

- working at voltage higher than 1kV and led in buildings, must be insulated from earthing elements of the building efficiently. You reach that by using insulated high-voltage cables or by keeping sufficient distance between the conductor and building frame. Do not use conventional electric cables.
- being laid in ground (in soil) must be protected by a fixed tube of insulators or use insulated high-voltage cables designed for this purpose again. Also ensure that the conduit is not damaged, for example by hooves of animals or tractor wheels that can plunge in the ground. Do not use conventional electric cables.
- may not be laid in a tube along with other distributing, communicating or data cables.

### Supply and connecting leads and electric line of fence system:

- shall not cross above overhead power or communication lines. Crossings with overhead power lines shall be avoided wherever possible. If such a crossing cannot be avoided it shall be made underneath the power line and as nearly as possible at right angles to it
- If are installed near an overhead power line, the clearances shall not be less than those shown „Table No. 3“

Power line voltage	Clearance
≤ 1.000 V	3 metres
>1.000 ≤ 33.000 V	4 metres
>33.000 V	8 metres

Table No. 3: Minimum clearances from power lines for electrical animal fences

- If are installed near an overhead power line, their height above the ground shall not exceed 3 m. This height applies to either side of the orthogonal projection of the outermost conductors of the power line on the ground surface, for a distance of:
  - 2 m for power lines operating at a nominal voltage not exceeding 1000 V
  - 15 m for power lines operating at a nominal voltage exceeding 1000 V
- Being nearby telephone line or telephone cable, must be conducted at a distance of minimum of 2 metres.

Electric animal fences intended for deterring birds household pet containment or training animals such as cows need only be supplied from low output energizers to obtain satisfactory and safe performance.

In electrical animal fences intended for deterring birds from roosting on buildings no fence wire shall be grounded if the fence wires are not connected to metal parts. If one wire is connected with a metal part (ie a gutter) or a metal structure of the building these metal parts must be grounded. A warning sign shall be fitted to every point where persons may gain ready access to the conductors.

Where an electric animal fence crosses a public pathway, a non-electrified gate shall be incorporated in the electric animal fence at that point or a crossing by means of stiles shall be provided. At any such crossing, the adjacent electrified wires shall carry warning signs. (see Figure No. 5).

Avoid direct contact with fencing, especially with head, neck or upper part of body. Do not creep through the fencing or over it. For passing the enclosure, use a gate or another point in installation designed for this purpose.

## Overvoltage protective equipment – lightning diverter

To prevent from damages caused by lightning, we recommend leading a circuit of fence system near to building via overvoltage protective equipment – lightning diverter fastened to outer masonry of the building by means of non-combustible materials before its connecting to energizer. This applied also for combined energizers, if they are used together with a network adapter.

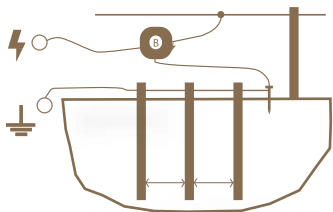

Figure No. 6: Overvoltage protective equipment with lightning diverter

Overvoltage caused by storm can cause insulation of electric fence system. In such a case, network voltage can get into electric fence system, and serious danger to people or animals can occur.

Generally, we recommend connecting network powered electric fence system only to such supply networks that are protected with earth-leakage circuit breaker with maximum actuating current of 30 mA. In addition to that, correct installation of energizer with auxiliary discharger and choking coil is necessary, as described within these instructions. It is suitable to disconnect network supplied electric fence system from network as well as from fencing (if possible) during storm.

If a network with earth-leakage circuit-breaker was not used for purposes of supplying energizer, and the energizer was connected to the fence system or the network during storm, it is necessary to check and test it before putting it into operation again.

For this purpose, connection to network with earth-leakage circuit-breaker must be available. For purposes of testing, connect earthing terminal of energizer to protective conductor of the supply network and connect pin to power socket protected with earth-leakage circuit-breaker then. If energizer beats correctly and does not show any deviations from normal operation subsequently, it can be connected to fence system again. If the earth-leakage circuit-breaker however falls out when energizer is connected, you must not use it and it must be repaired professionally.

If connecting lines of this energizer are damaged, they must be replaced by manufacturer or authorized service or another qualified person so that possibility of danger is excluded. Service and repairs of these energizers must be performed by authorized persons only! Each user of electric fence system is responsible for its operation and should perform regular checks of energizer and fence system at least once a day, depending on operating conditions!

Procedure of checking:

- Visual control of energizer and fence system
- Measuring of minimum voltage of 2500 V in every place of the fence system

If installation is performed inside a building, energizer may not be operated in a room with increased risk of fire in any case (barn, shed, cattle shed). In addition to that, no combustible materials may be stored near to fence system and connectors of energizer. Installation of energizer must be made on a fire-resistant surface.

**For stable using, use only energizers designed for that purpose!**

Do not connect battery or accumulator energizers to electric power network or devices being connected to network voltage, except for sources determined to that by the manufacturer, in any case. This energizer may not be used by persons (including children) who have limited physical, perceptive or mental abilities or do not possess sufficient experiences and knowledge, when they are not under supervision or are not trained for operating energizer by persons who are responsible for their safety. Children should be under supervision so that there is not chance that they play with the energizer.

Ensure that all connected network supplied auxiliary circuits have at least the same protection class as energizer.

**Electric fence system must be used in accordance with description mentioned in the instructions for use.**

## 14. TROUBLESHOOTING - POSSIBLE FAULT SOURCES – REDUCTION OF FENCER FUNCTIONALITY

In case that electric fence system does not give pulse or voltage is lower than 3 kV and red diode is blinking on BARGRAPH indicator, it is necessary to check below listed causes.

Cause	Fault removal
Energizer does not work?	Disconnect the device from the fence system and switch it on again! If blue or violet LED is burning and yellow or green LED is flashing on BARGRAPH indicator, then the device works properly. Otherwise, the device is damaged (contact your salesman). When using battery and accumulator devices, observe correct wiring of poles.
Red LED light is blinking	Battery voltage decreased below 12 V - replace the battery with a sufficiently charged one or connect adapter.
Red LED light is blinking and warning siren sounds (beeping)	Battery voltage decreased below 11,6 V - replace the battery with a sufficiently charged one or connect adapter.
No LED signal is burning	Energizer is switched off manually or battery voltage decreased below 11,4 V and energizer was switched off automatically. Reason is protection of battery from its deep discharge (and battery destruction). Replace the battery with a sufficiently charged one or connect adapter – until battery voltage reaches at least 12 V, red LED will be burning.
Lead-in or short circuit of supply lines of the fence system	Do not use conventional cables for supply lines. High-voltage cable is recommended.
Conductor has adverse properties (thin diameter, high resistance)	Use high-quality conductor with low resistance and larger diameter. Ensure high-quality correct connection of conductors.
Low-quality earthing, too short earth rod, corrosion, dry soil	Add next rod, moisten.
Lead-in via growth near fence system	Remove the growth (mow it).
Conductor on ground (for example break, insufficient mechanical tension)	Repair fencing, use special connectors, stretch conductor.
Too long fence system. Was correct accessories used for given purpose?	Use accessories suitable for given length of fence system and for animals – in case of need, consult specialized salesman.
Insulator pierces, losses occur	Replace defective and weather-worn insulators.
Conductor is connected via knot, insufficient connection	Use relevant special connectors for the conductor.
Remote controller doesn't work	Empty battery. Replace it with a new one. Put with correct polarity.

Table No. 4: Possible fault sources

## 15. GUARANTEE

In addition to a guarantee requested by law, we provide you with a guarantee in accordance with below listed conditions:

- Guarantee period begins on the day of its purchase. Guarantee claims are acknowledged explicitly pursuant to submission of bill or cash voucher. Guarantee repair is free of charge, or we reserve the right to deliver a device of the same value.
- Guarantee is valid in case of correct use in accordance with the instructions for use. It expires in case of interferences by unauthorized persons and in case of using spare parts of foreign origin.
- All deficiencies resulting from material defects or manufacturing defects shall be removed in manufacturer's discretion by repairing or free-of-charge replacement of the energizer.
- In case of delivering spare parts or repairing, original guarantee period is not prolonged.
- Guarantee period and address of guarantee provider can be found in attached instructions for use of given type of energizer.
- Accumulators or batteries of any type, damages due to overvoltage (caused by lightning among others) and damages due to spill-over of accumulator acid are not included in the guarantee.

**This energizer is provided with guarantee period of 3 years according to our conditions for guarantee! Safety instructions, earthing, putting into operation, care of batteries and accumulator, conditions for guarantee and possible fault sources can be found in attached instructions for use!**



# RECOMMENDED INSTALATION OF CONDUCTORS

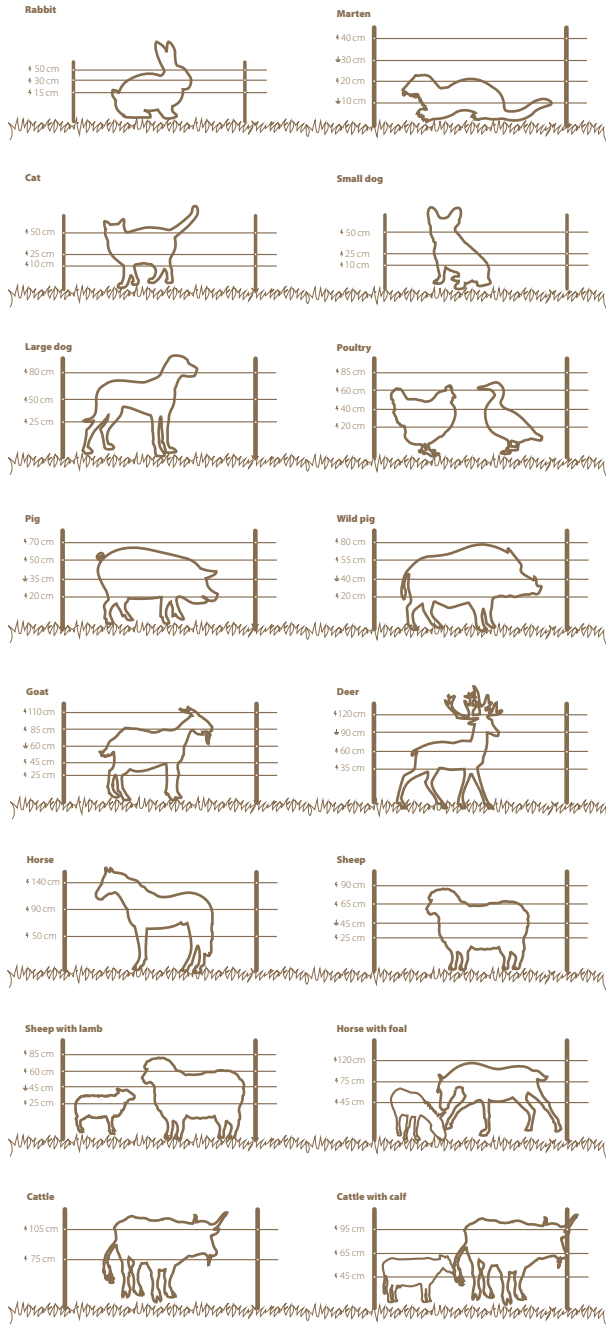

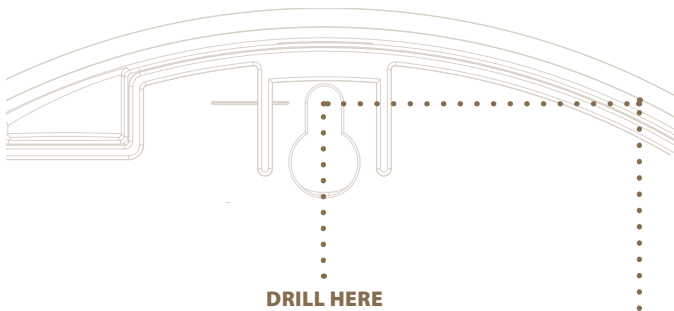

**DRILL HERE**

**TEMPLATE FOR DRILLING**  
SCALE 1:1

157 mm

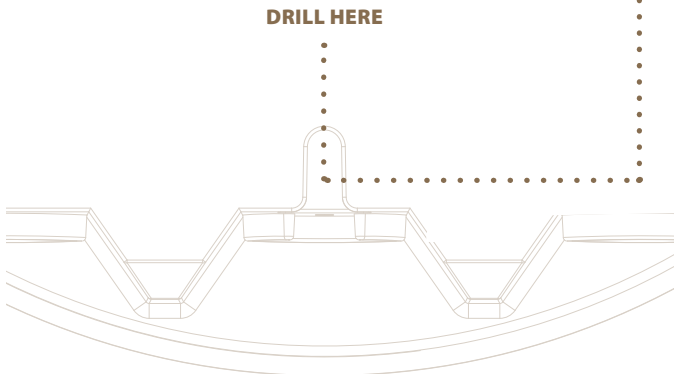

**DRILL HERE**

## FUNCTION & BENEFITS



**Czech product**



Easy use and comfortable switching thanks to the **ON/OFF button**.



Special **ST transformer**, extra high voltage with long term protection.



Modern **LED diodes** with **BrightLight** technology offering high luminosity.



**Smart Control** technology provides **microprocessor controlled** operation and optimum performance.



Very **low and efficient energy consumption**.



The **SafeShock technology** ensures **maximum safety for your animals**. Specially shaped impulse curve.



**On-wall installation is very easy.** Practical installation **DIN rail** is one of many accessories available.



Fence energizers are **resistant to all climatic conditions**. Rain, direct sunlight and frost.



Complies with European Directive **2014/35/EU - 2014/30/EU**



**3 years warranty.**

## Additional functions of fence **power DUO PD**



**Battery management**  
Checking and managing the battery status.



**Power Switching**  
Manual switching between high and low power  
Optional for the user to save battery when needed.



**Time delay 50 s**  
Increase power to maximum power for safety reasons.  
**Only power DUO PD 70 | power DUO RF PDX70.**



**Combined power supply**  
Power supply is possible from a 230 V network using an adapter or from a conventional 12 V battery, also usable as a backup supply.



**LED Bargraph**  
Visually gives information about the state of the fence.



**Award Zlatý Klas 2018**  
Energizer **power DUO PD50**

## Additional functions of fence **power DUO RF PDX**



Transmitter range **up to 10km**.



**Current information** about the fence.



**Comfort** - saves unnecessary trips to the fence



**Award Zlatý Klas 2019**  
Energizer **power DUO RF PDX50**



**Alarm signalling.**



The package **power DUO PD / power DUO RF PDX** contains an AC adapter.



**No SIM CARD needed.**



fencee

16012020

fencee

**ENERGIZER**  
FOR ELECTRIC FENCE SYSTEM

Stamp and signature of seller:

**Respect.**   
**Care. Innovation.**

**VNT electronics s.r.o.**

Dvorska 605, 563 01 Lansroun  
Czech Republic  
info@fencee.eu

 fencee.cz  fenceeczecch

info@fencee.eu  
www.fencee.eu  
+420 730 893 828